

STUDIO SERVICES



TECH PUBLICATIONS



AUTHORING

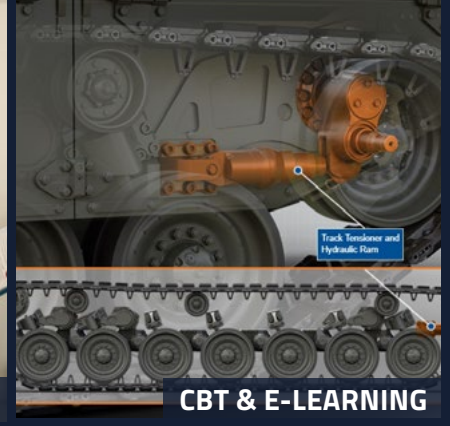

CBT & E-LEARNING

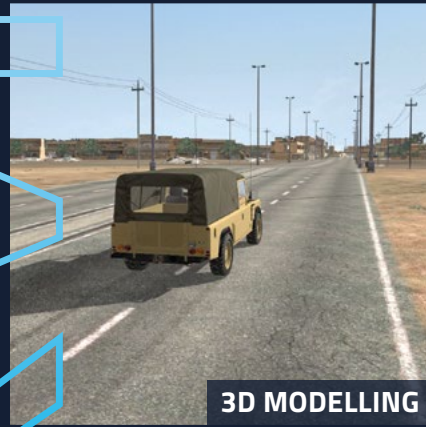

3D MODELLING

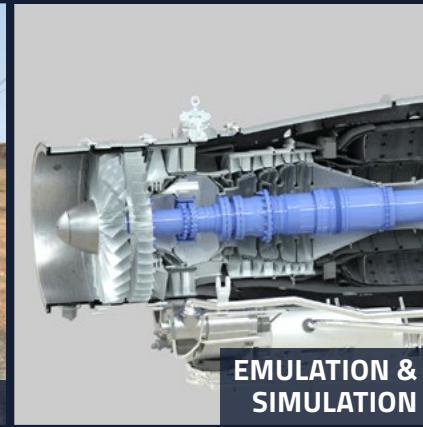

EMULATION & SIMULATION



VIRTUAL REALITY

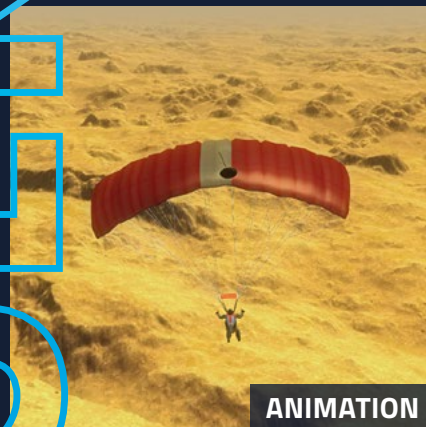

ANIMATION



GRAPHIC DESIGN



ILLUSTRATION

WE THINK

WE CREATE

WE INNOVATE

WE DEVELOP

Studio Services is a team of highly-skilled, qualified professionals, producing creative solutions and technical publications for a wide range of clients - ranging from SMEs, to government departments and large blue-chip multi-national companies.

Thinking big for decades.

We create bespoke solutions to fulfil your needs.

Our capabilities and experience allow us to provide cutting-edge solutions:

- **Technical Publications & Illustration:** CAD & S1000D-compliant, XML-formatted publications
- **CBT & E-learning:** Design, creation and delivery for a wide range of industries
- **3D Modelling:** Animation and 3D modelling
- **Virtual Reality:** In all levels of VR simulation
- **Graphic Design:** Branding, artworking and creative design

Our portfolio covers the breadth and depth of our competences, covering small campaigns to specialist large programmes. Translation, printing and account management available.

WE THINK
WE CREATE
WE INNOVATE
WE DEVELOP

Pennant



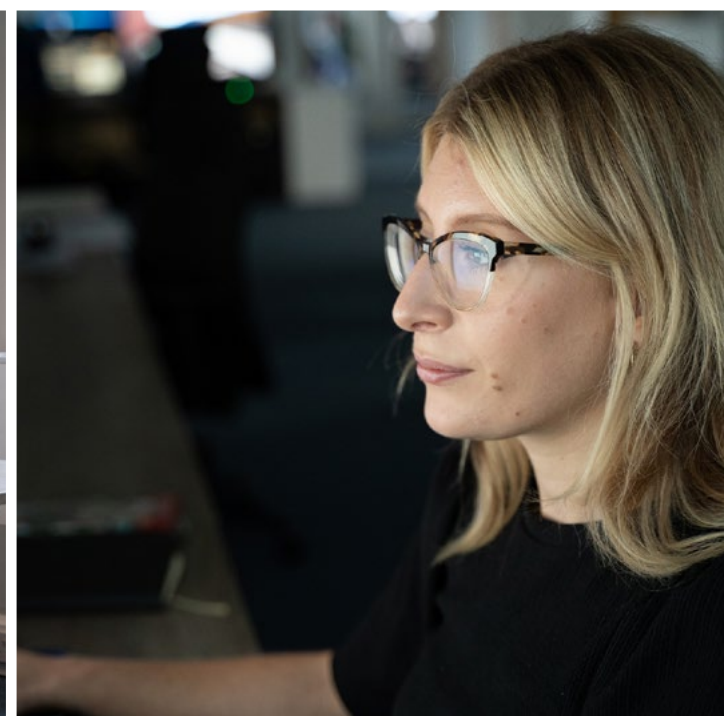
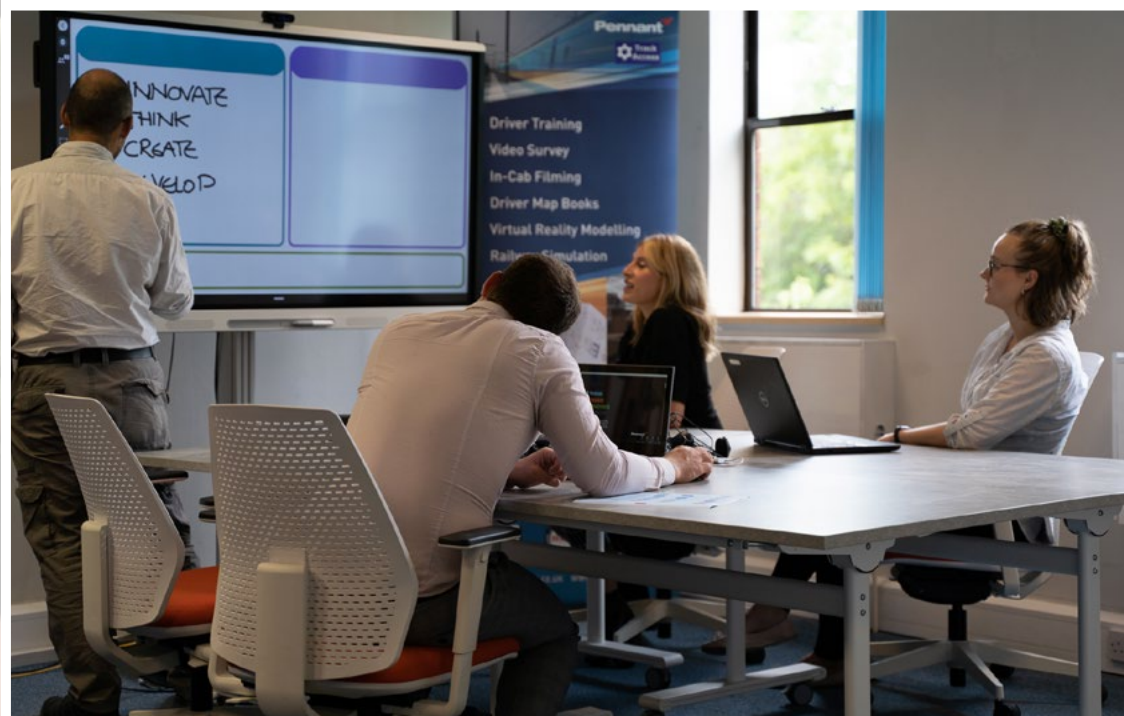

TECHNICAL PUBLICATIONS

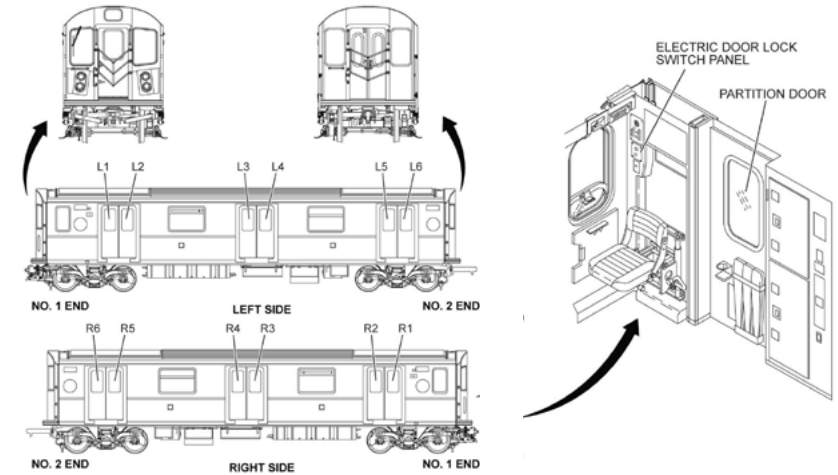
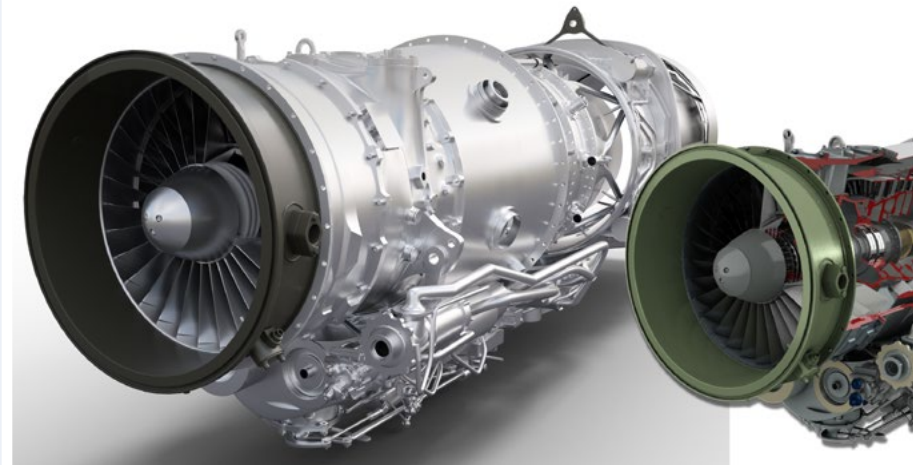
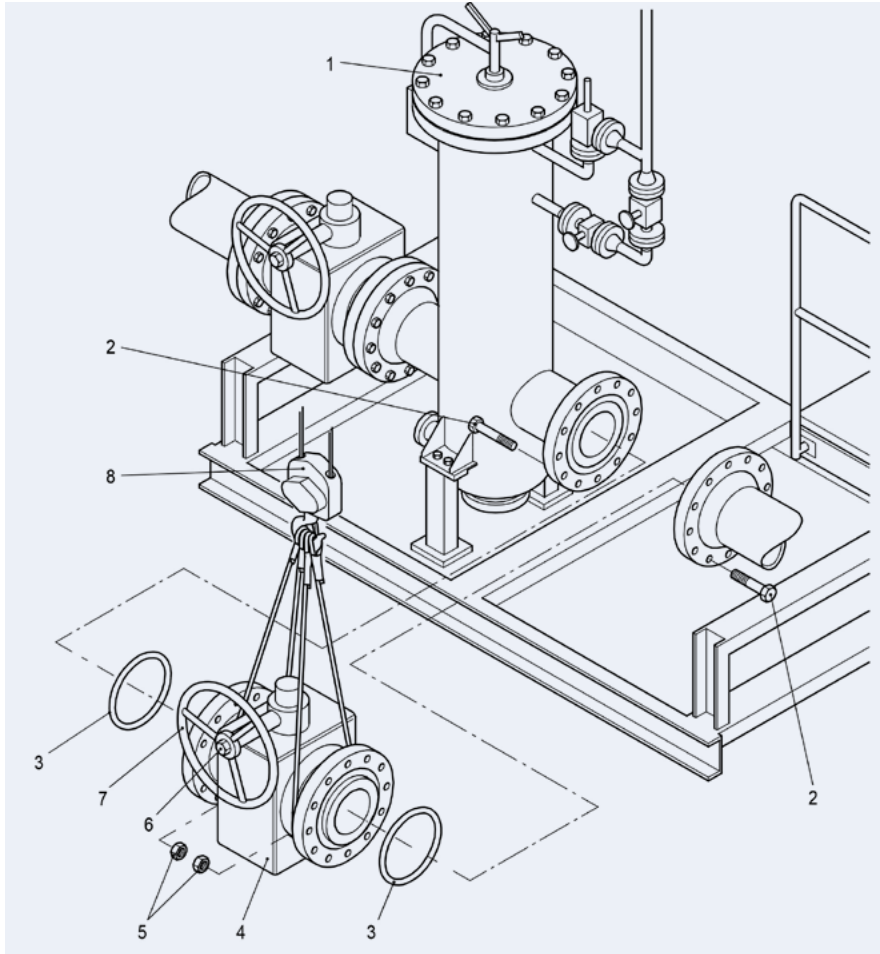

The Pennant team of authors, illustrators and consultants have the ability to manage, develop, and deliver complex source data into a variety of technical publications, such as Operation and Maintenance Manuals, Parts Catalogues and training courseware. With the combined knowledge of our global team, leveraging the market-leading R4i suite, our capabilities continue to expand as we evolve.

Traditional hard copies and interactive electronic technical manuals (IETM) can be produced to any industry standard, including S1000D. Formatting, editing, publication and printing services are included. Translation services are also available.

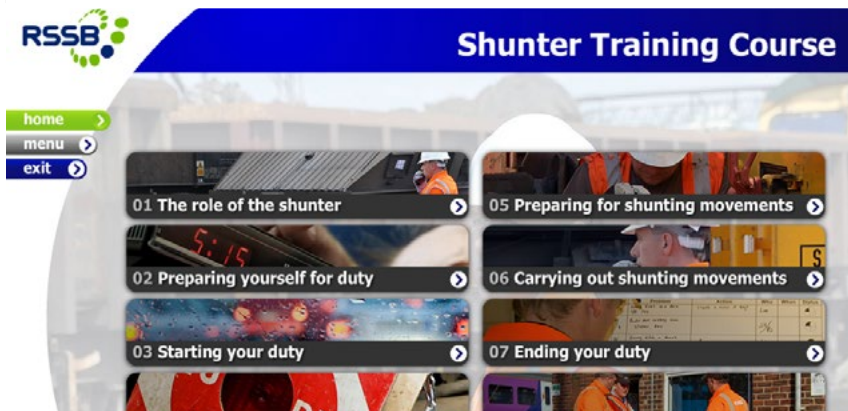

CBT & E-LEARNING

For more than 30 years, Studio Services have created interactive, self-paced or instructor-led SCORM-compliant and white-labelled computer-based training. The fully customisable designs can include problem solving tasks for students, with exact mapping and reconstruction for lessons learned, in a low-risk, standardised environment.

Integrating with computer and telephone logs, courseware can simulate real-world environments and exams and tests can be incorporated within the learning programme.

3D MODELLING

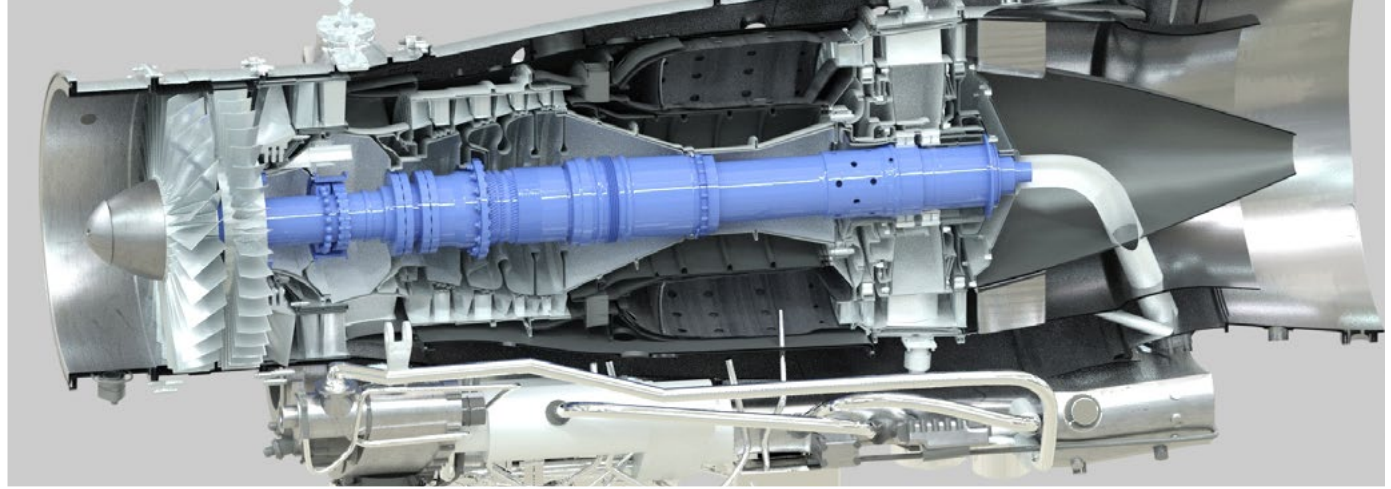

Our 3D simulation & emulation experts have over 20 years' experience in the virtual worlds, working with a wide range of applications to create high-quality, fully adaptable models and animations for any modern device.

3D models and animation can give total precision and control, all in a risk-free environment, with the added value of being quick and easy to change and re-model. The animations we create improve and support training by explaining scenario videos, and will easily integrate with CBT & E-learning resources. Historic projects have included reconstruction videos and scenario-based problem solving.



VIRTUAL REALITY

For over 10 years, our dedicated award-winning team have been working in all levels of Virtual Reality, creating realistic and high-fidelity visuals for a variety of customers.

Our immersive and interactive experiences can suit any purpose, delivered through VR headsets and controllers. Ideal for simulating high risk situations, VR allows fully recordable activities in room-scale tracking, and the ability to have multiple students working co-operatively in real time, for effective learning and training. Optional assessments with after-action reviews can also be built within the systems.

GRAPHIC DESIGN

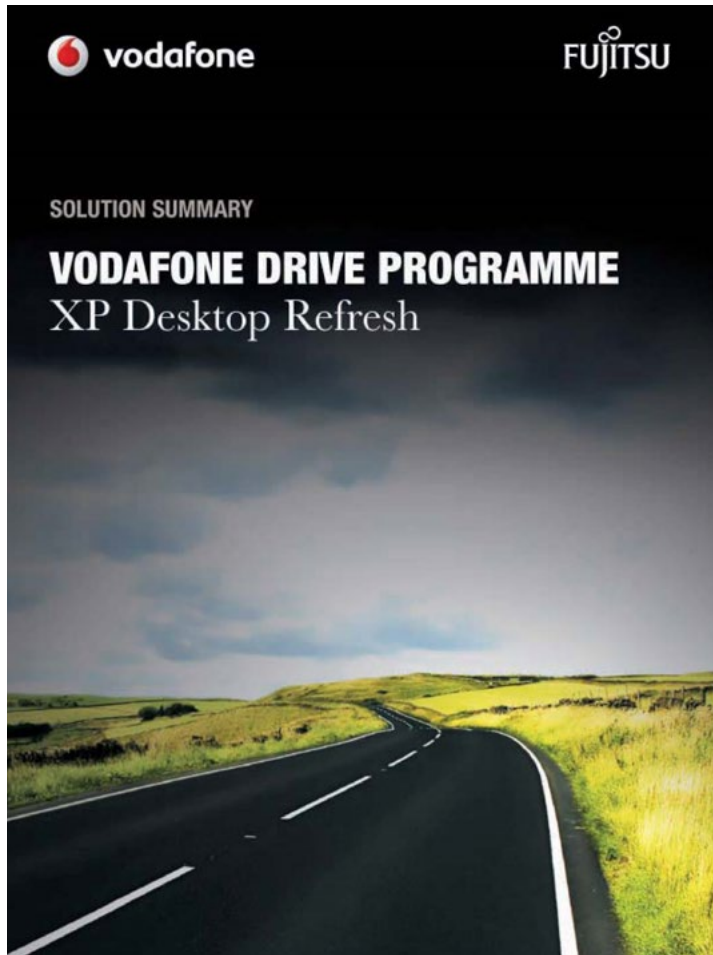

With over 20 years' experience in branding and artwork communication, our highly qualified designers can create effective and aesthetic visuals for any client, putting marketing plans and concepts in to print, social and digital formats. Campaigns range from small to large, and can be created around exact needs, budgets and themes, with our team offering dedicated and professional account management support at every step.

Our capabilities include: branding, brochures, logo design, advertising, large format artwork and exhibition stand design.

The image shows a large, modern building with a glass facade. A sign on the building reads "Pennant" in a bold, sans-serif font, with a red triangle to the right of the text. The building is set against a dark, overcast sky. In the foreground, there are some green bushes and a paved area.

Pennant

**AIM Stock market registered public limited company.
ISO 9001:2015 registered, BSI member, British Safety Council member
and Cyber Essentials accredited.**



**Pennant International Ltd's Companies House no 00599464
Pennant International Ltd's VAT no GB 275 6328 35**

An award winning team of designers, developers, artists & authors.

Our highly qualified team are specialists in the technical sectors, creating a range of solutions in any format, at any scale.

Using innovative software and the latest programmes, Studio Services can deliver - from concept to creation.

Get in touch to discuss what we can do for you:

sales-TTD@pennantplc.com

Issue 1. This document is copyright © Pennant International Group Plc. All rights reserved.

This document is provided for information purposes only; contents are subject to change without notice. It is not warranted to be error-free, nor subject to any other warranties or conditions including implied warranties and conditions of merchantability or fitness for a particular purpose.